

LED LAMP
NORMALLY UNLIT
PUSH LIT

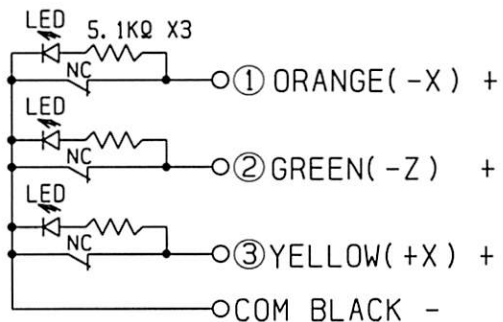
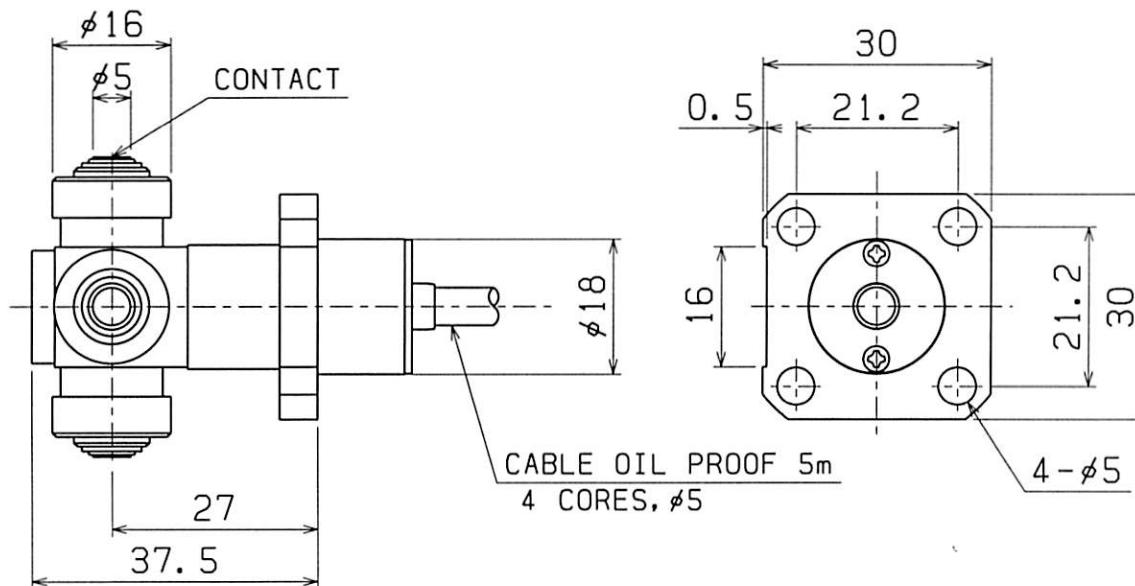
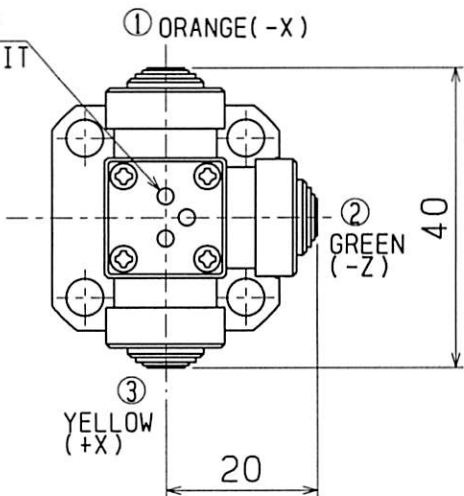

SET NUMBER : H3A-36-04S

COMPOSITION [SENSOR HEAD H3A-36-04H
POLARITY CONVERTOR UNIT BA-4A

	NAME	TOOL SETTING PROBE
A 4	DRAWING NUMBER	H3A-36-04S
1 : 1		